



Electric NetMat

Installation Instructions for Electric Radiant Floor Heating

I. General Information	2
II. Floor Structures	2
III. Electrical Preparations	3
IV. Preparation Before Installation	4
V. Installation	4-5
VI. Layout Tips	6-8
VII. Labeling Instructions	9

U.S. Floor Heating's NetMat Structure

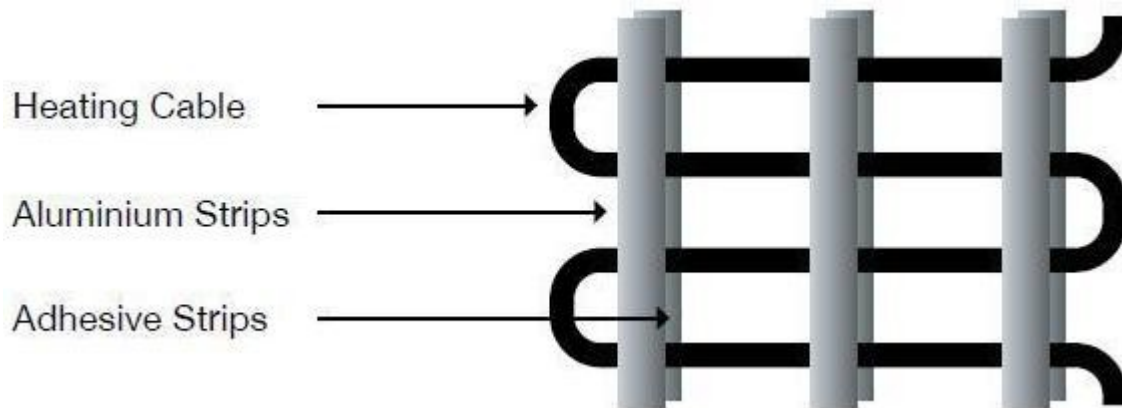



I. General Information

1. Read instructions carefully.
2. NetMat can be installed under carpet, wood, laminate, ect., floor covering.
 - a) The NetMat should not be installed under fixed cupboards, cabinets, under bath tubs, in walls, ceiling.
 - b) The NetMat is not intended for installation under floors in the joist space.
 - c) DO NOT install on wood subfloor or under combustible floor coverings.
 - d) Install on concrete mortar or cement backer board subfloor.
3. The NetMat can be installed in any indoor room, including bathrooms.
4. THIS EQUIPMENT SHALL BE INSTALLED ONLY BY QUALIFIED PERSONNEL WHO ARE FAMILIAR WITH THE CONSTRUCTION AND OPERATION OF THE APPARATUS AND THE RISKS INVOLVED.
5. THE INSTALLATION OF THIS HEATING PRODUCT SHALL BE IN ACCORDANCE WITH THE MANUFACTURER'S INSTRUCTIONS AND THE REGULATIONS OF THE AUTHORITY HAVING JURISDICTION.
- 6. NO MODIFICATIONS ARE ALLOWED TO BE MADE ON THE PRODUCT (DO NOT CHANGE THE MAT SIZE OR OPEN THE FACTORY SPLICES) – NEVER CUT THE WIRE! MATS RUN IN ELECTRICAL PARALLEL! DO NOT CONNECT THE MATS IN A SERIES CIRCUIT!**
7. Do not install Mat if the temperature is below 41°F (5°C).
8. For this installation you will need: a scissors, a broom, solvent, Ohm meter to test wire
9. If insulation needs to be installed please insure that the R-value under the heating element will not be more than 19 and above the heating element will not be more than 2.5 (For more information see table on page 6 #13). The installation of the insulation must be according to the insulation installation manual.

II. Floor Structures (from top to bottom)



1

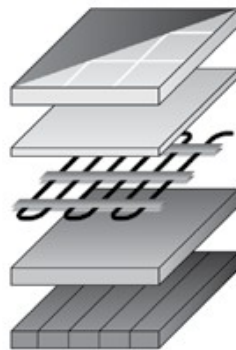

2

1. Finished floor (with R-value not more than 2.5)
Cover Layer
NetMat
Insulation
Concrete sub-floor
2. Finished floor (with R-value not more than 2.5)
Cover Layer
NetMat
Concrete Board
Wood sub-floor



III. Electrical Preparations

NOTE: THIS STEP SHOULD BE CARRIED OUT BY A QUALIFIED ELECTRICIAN!

1. Please check that your system is 110 Volt or 220 Volt and follow the local code for its preparation. (See table on page 10 for individual rating)
2. Install all necessary rough-in for the thermostat (illustration 1 shows the rough-in for up to 3 mats. Illustration 2 needs to be added if you have more than 3 mats). For specialized rough-in

Vertical Single Gang Box with minimum 22 Cubic inch capacity.

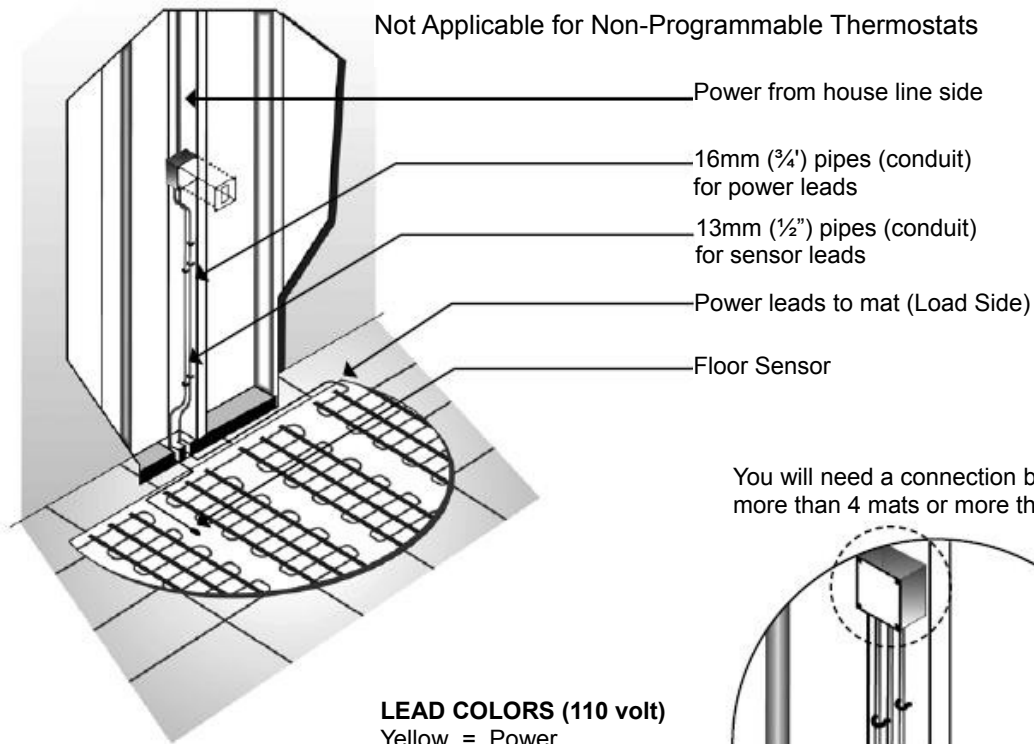

Not Applicable for Non-Programmable Thermostats

Power from house line side

16mm (3/4") pipes (conduit)
for power leads

13mm (1/2") pipes (conduit)
for sensor leads

Power leads to mat (Load Side)

Floor Sensor

You will need a connection box if you have more than 4 mats or more than 16 amps.

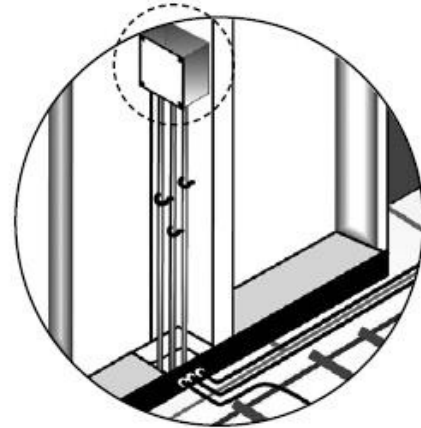

LEAD COLORS (110 volt)

Yellow = Power
White = Neutral

LEAD COLORS (220 volt)

Red = Power
White = Power

3. Power leads must be protected as per local code.
4. The installation shall be made in accordance with article 424, Part J, of the National Electrical Code ANSI/NFPA 70.
5. A breaker with G.F.C.I. must protect the circuit.
6. Install and program the thermostat in accordance with the installation instructions.
7. Type NM and NMC non-metallic sheathed cable is not suitable for installing this product.
8. Please use as a minimum wiring type solid THHN AWG 14 to feed the system .

WARNING: MAKE SURE HEATING WIRE IS NOT CONNECTED TO THE POWER SUPPLY UNTIL ALL INSTALLATION IS COMPLETED AND TESTED! HEATING WIRE MUST RUN PARALLEL, NOT SERIES!



IV. Preparation Before Installation

1. Each step of the preparation process is essential to insure a quality installation.
2. Remove all obstacles from the sub-floor and make sure the sub-floor is free from all dirt, nails, sawdust and other construction residue.
3. Plan the NetMat layout, thermostat location, rough-in, and power supply from the main panel before any installation.
4. Make sure that the mat size fits the applicable area in accordance with your plan.

V. Installation - Step by Step

1. Mark thermostat and conduit location.
2. Install the electrical prop and conduit (to be done by approved electrician).



3. Clean floor surface.



4. Mark each heating mat location on the sub-floor in accordance with the plan. Make sure that heating cables do not extend beyond the room or the area for which it was designed.



5. **Test No. 1:** Test the heating mats, before rolling them out, with an ohmmeter. The results should be 5% above or 10% below the tag value. If the resistance is above or below please call us (The calculation for the expected resistance is voltage squared divided by the wattage of the mat. $V^2/W = Ohms$)



6. Place the NetMat on the marked area and roll out in accordance with the plan. Make sure to leave at least 1 foot from the wall, 3 foot from any heating elements.

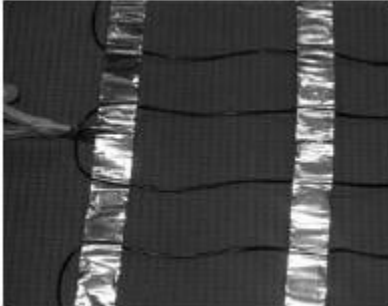

7. Cut the Fiberglass Mesh for the mat to fit around obstacles (never the cable!). Always cut away from the wire. (For alternative cutting options see examples at the end of the installation instructions.) Use a mild solvent on scissors to prevent adhesive from accumulating on the scissor blades.



8. After cutting NetMat Fiberglass Mesh, turn around the heating roll to allow unrolling in the new direction. The straightened loop of wire will naturally set the distance between the old and the new run of mat. Make sure that the distance between the cables will not be less than 2½ inches.

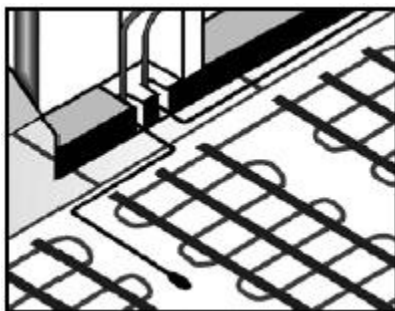

9.a) **WARNING** - Risk of electric shock and fire, damage to supply conductor insulation may occur if conductors are routed less than 2 inches (51mm) from this heating product. Refer to installation instructions for recommended means of routing supply conductors.

b) Pull the cold lead through the conduit to the thermostat box. Pull the sensor cable from the floor to the thermostat box through a separate conduit. The sensor is low voltage and does not go in the same conduit as the power leads. (All connections should be performed by an approved electrician). Place the sensor between the mat cables without allowing the sensor to contact the heating wire.



10. Remove the paper strip on the adhesive tape from the beginning of the mat. Remove the middle strip first and then the side strips. When taping the wire, tighten the slack in both directions to make the wire tight to the floor.

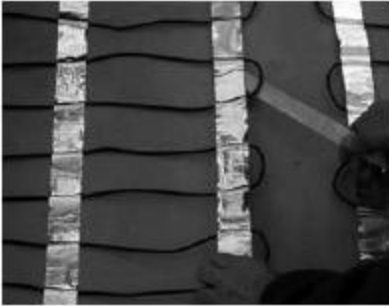

11. Make sure that all the fiberglass adhesive is well glued to the floor. If any wire sticks up, use a small piece of duct tape to hold it down

12. **Test No. 2:** Repeat test described in step 5.

13. The Floor is now ready for tiling. If there is to be a cover layer, make sure it is a minimum of 3/8 inches thick. If insulation installed please insure that the R-value above the heating element will not be more than 2.5

Estimated R-values for the most common floor covers:

Harwood Flooring	1" thick	0.91
Harwood Flooring	3/4" thick	0.68
Tile linoleum		0.05
Carpet	With Fibrous pad	2.08
carpet	With Rubber pad	1.23

Please check with your floor cover supplier for the R-value.

14. A qualified electrician should carry out step 15!

a) **Test No.3:** Test according to step 5.

b) Install thermostat in accordance to the manufacturer's instruction and IEE regulation.

- Carry out the GFCI test.

- Ensure mat load (Amperage) does not exceed the thermostat switching rating (16 Amp)

- Label the panel circuit in accordance with your local code.

15. Switch on the circuit breaker and thermostat and follow thermostat instructions for programming.

Ensure mortar/screed/leveling compound is cured dry in accordance with the manufacturer's specifications prior to energizing the mats.

16. Do not install or setup any element like cabinets, furnishes, carpets etc that will act as an insulator over the heating element location in the room to prevent overheating which is dangerous.

17. Please attach the labels included in your package following the *Labeling Instructions* given on page no.11.

For any inquiry, please contact :

phone: 866 – 537 - 8232

fax: 262 – 364 - 3999

email: info@usfloorheating.com



VI. Layout Tips - Examples

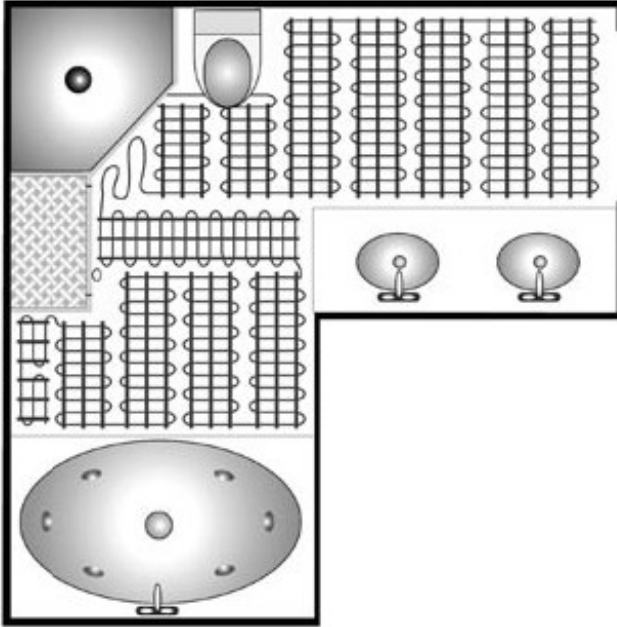

Bathroom Layout

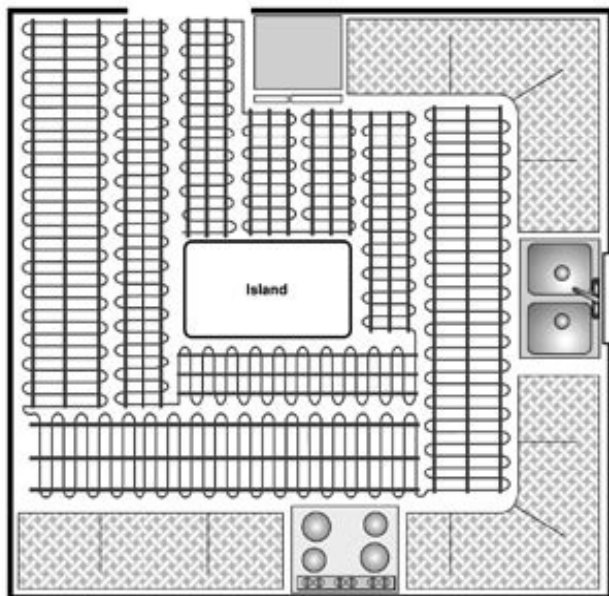

Kitchen Layout



VI. Layout Tips - Do's and Don'ts

DO!

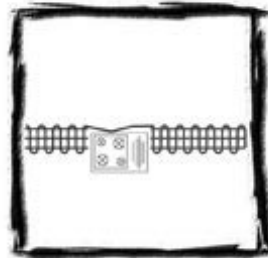
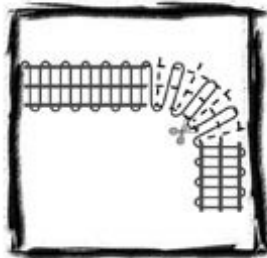
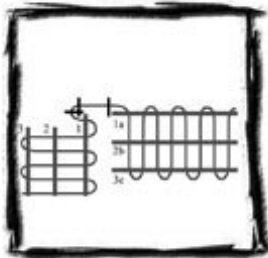
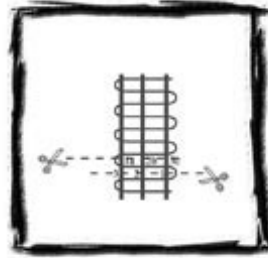
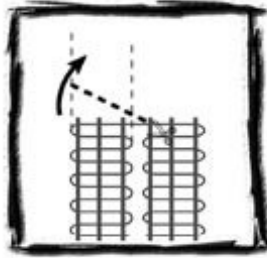
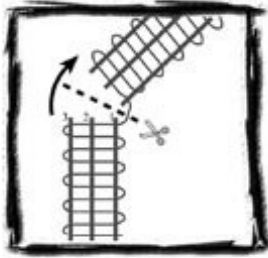

DON'T!

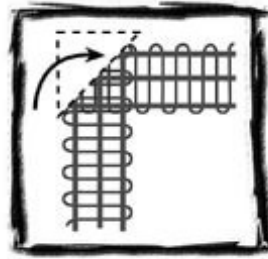
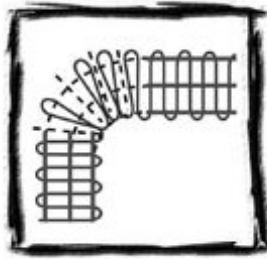



VI. Layout Tips - Step by Step

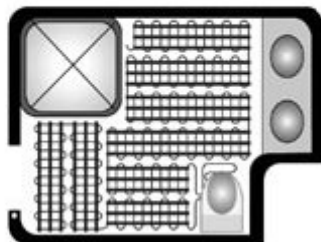
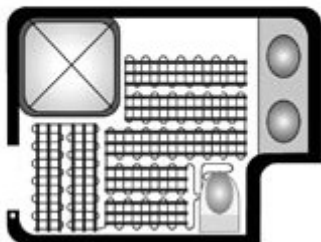
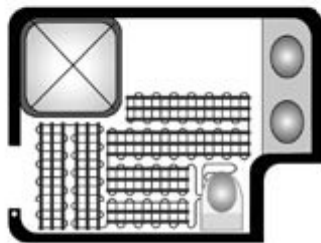
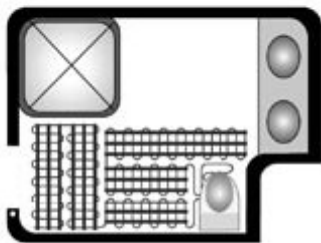
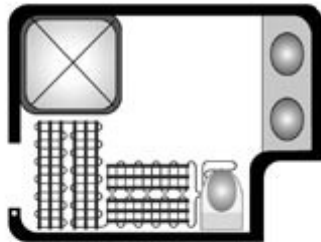
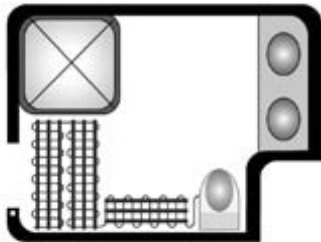
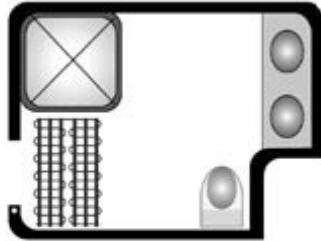
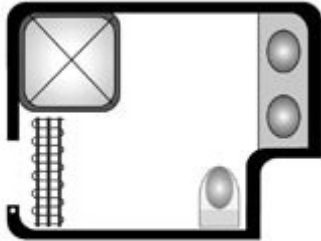



120 Volt

VII. Individual Rating Table

pg10

Size in Sq''ft	Watts/sq''ft	Total Watt Output	Amperage per unit
10.5	12	126	1.05
13.5	12	162	1.35
20	12	240	2
25.5	12	306	2.55
31.5	12	378	3.15
35	12	420	3.5
40	12	480	4
49	12	588	4.9
57.5	12	690	5.75
62.5	12	750	6.25
Size in Sq''ft	Watts/sq''ft	Total Watt Output	Amperage per unit
9.5	15	143	1.19
12	15	180	1.5
18	15	270	2.25
23	15	345	2.88
28	15	420	3.5
31	15	465	3.88
36	15	540	4.5
44	15	660	5.5
51	15	765	6.38
56.5	15	848	7.06

240 Volt

Size in Sq''ft	Watts/sq''ft	Total Watt Output	Amperage per unit
21	12	252	1.05
27	12	324	1.35
40	12	480	2
51	12	612	2.55
63	12	756	3.15
70	12	840	3.5
80	12	960	4
98	12	1176	4.9
115	12	1380	5.75
125	12	1500	6.25
Size in Sq''ft	Watts/sq''ft	Total Watt Output	Amperage per unit
19	15	285	1.19
24	15	360	1.5
36	15	450	2.25
46	15	690	2.88
56	15	840	3.5
62	15	930	3.88
72	15	1080	4.5
88	15	1320	5.5
102	15	1530	6.38
113	15	1695	7.06



VII. Labeling Instructions

Label 1 – to be placed on the electric panel boards

WARNING:

RISK OF ELECTRIC SHOCK – ELECTRIC WIRING AND HEATING PANELS CONTAINED BELOW THE FLOOR. **DO NOT PENETRATE FLOOR WITH NAILS, SCREWS, OR SIMILAR DEVICES**

Label 2 – to be placed on the electric panel boards

CAUTION:

RADIANT HEATING PRODUCTS INSTALLED IN THIS AREA. AVOID ACTIONS WHICH MAY RESULT IN MECHANICAL DAMAGE TO THE PRODUCT.

Room name	Volt rate	Total output	Number of units

Label 3 – to be placed on the heating control

RADIANT FLOOR HEATING